

## LFP12.8-135

Lithium iron phosphate battery



## LITHIUM SERIES

### Characteristics

Electrical		
Nominal voltage		12.8V
Nominal capacity at 5 hours rate (25°C)		135Ah
Energy		1728Wh
Charge Efficiency at 0.2C (25°C)		99.5%
Discharge Efficiency at 1C (25°C)		96-99%
Approx. internal resistance (25°C)		≤50.0 mΩ
Cycle life / 0.2C 100% D.O.D		>2000 cycles
Capacity affected by temperature	40°C	101%
	25°C	100%
	0°C	90%
	-10°C	75%
Mechanical		
Dimensions	Length	330±2mm (12.99inch)
	Width	172±2mm (6.73inch)
	Height	215±2mm (8.43inch)
	Total height	220±2mm (8.66inch)
Terminal type		T16
Torque		2.3±2.5N.m
Weight		13.8kg (40.56lbs)±4%
Water & Dust resistance		IP65
Battery container ABS UL94-HB		V-0 optional
Cell strings		4 strings
Temperature		
Nominal operating temperature		25°C±3 (77±5°F)
Operating temperature range	Discharge	-20°C~60°C (-4°F~140°F)
	Charge	0°C~45°C (32°F~113°F)
	Storage	0°C~40°C (32°F~104°F)
Charging		
Charging voltage at 25°C		14.6V
Standard charge mode (25°C±2°C, <75%RH)		0.2CA Constant Current to 14.6V, then Constant Voltage 14.6V until the current drops to 0.02CA. Rest 30 minutes, before use.
Nominal charging current		27A
Maximum charging current		67.5A
Charging cut-off voltage		14.6V
Discharging		
Continuous discharge current		150A
Maximum pulse discharge current (<100ms)		400A
Discharge cut-off voltage		11.2V
Self discharge rate (25°C)		≤3%/month
Communication & connection		
Communication protocol (optional)		RS485 (standard none)
SOC (optional)		LED/Bluetooth
Maximum modules in paralel or series		4 in string, 6 in parallel

### Overview

NPP Power Lithium-Iron Phosphate batteries offer superb improvement in characteristics compared to lead-acid technology. Due to the extreme cycle and calendar life, LiFePO<sub>4</sub> batteries are an excellent long-term investment for your applications. Powerful, lightweight, safe, and smart, the Lithium-Iron Phosphate batteries are the future of the energy storage you can have right now.

### Features

**Longer cycle life** - Up to 15 times longer cycle life and 5 times longer float/calendar life than lead-acid batteries.

**More capacity** - Provides up to 100% of usable energy.

**Lightweight** - 60% lighter than lead-acid batteries.

**High discharge rate** - Ability to fully discharge the battery at a high rate of discharge.

**Fast charging** - Charges much faster than conventional sealed lead-acid batteries.

**Long cycle life** - More than 3000 cycles at 100% depth of discharge.

**Intelligent BMS** - The battery management system monitors and adapts to battery conditions to maximize performance and safety.

### Dimensions & Terminal Type (mm)

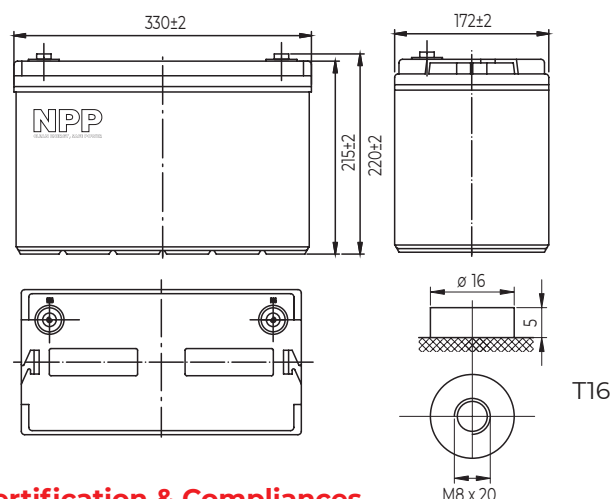

### Certification & Compliances



Compliant to: IEC 62133-2

The data in this document is subject to change without notice and become contractual only after written confirmation. Please contact NPP Power for the latest available version.

#### Guangdong NPP New Energy Co., Ltd.

No.3 Hongli Road, Miaobian Community, Liaobu Town, Dongguan, Guangdong Province, China.

#### Guangzhou NPP Power Co., Ltd.

No.67 Lianglong Road, Huashan Town, Huadu District, Guangzhou, China.  
Email: info@nppower.com.cn Tel: +86 20 37887 390

# LFP12.8-135

Lithium iron phosphate battery

# LITHIUM

SERIES

Discharge characteristics (25°C)

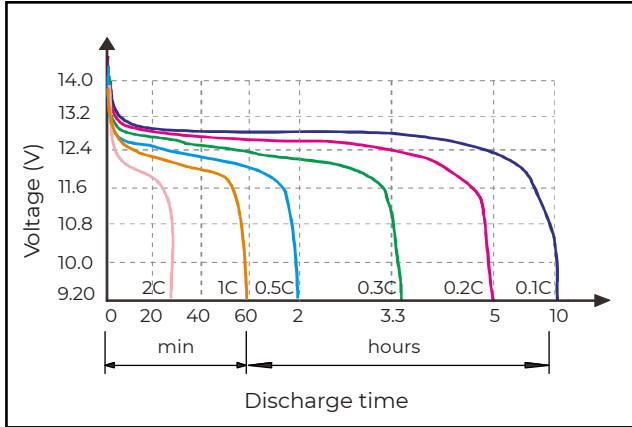

Temperature effects on discharge (0.5C)

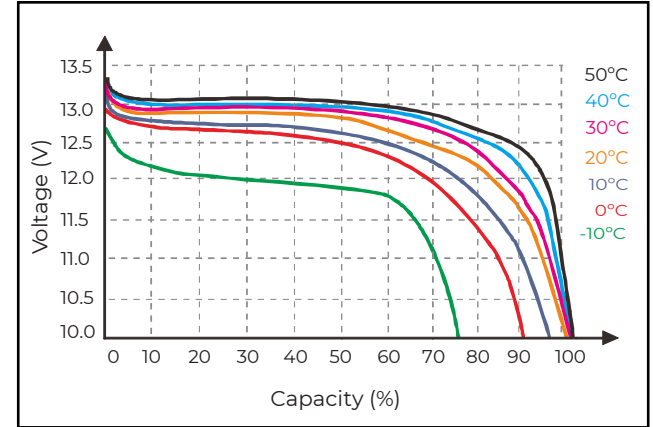

Charging Time on S.O.C. (25°C)

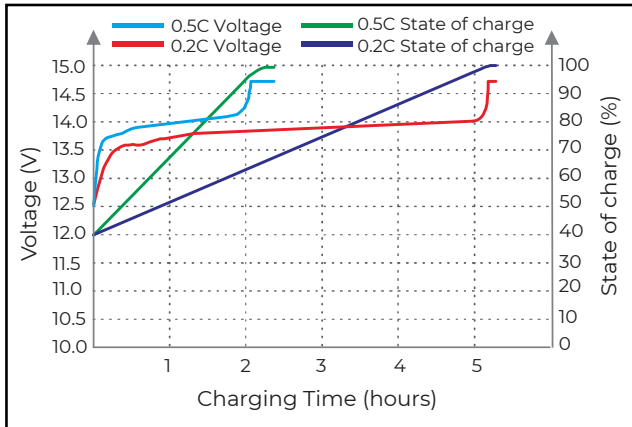

Charge characteristics (25°C)

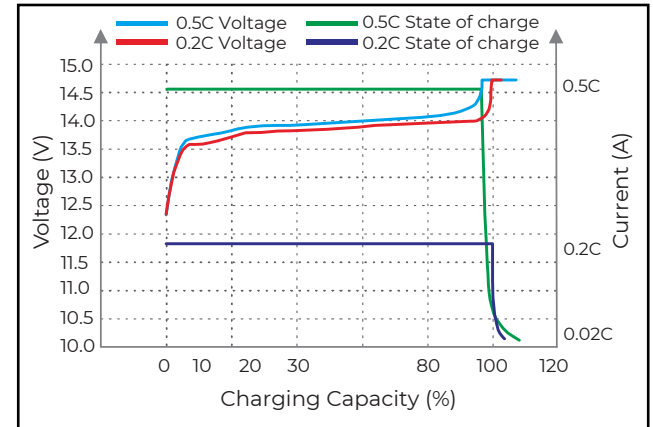

Cycle life on D.O.D. (25°C)

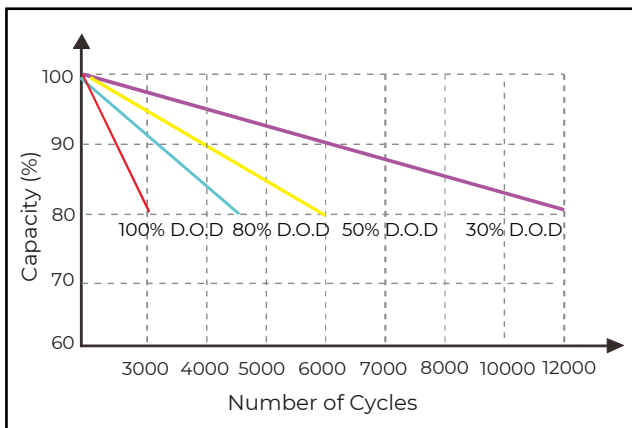

Self discharge characteristics

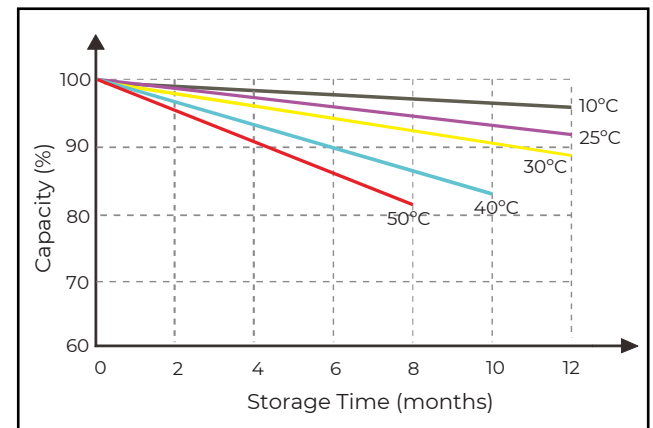

D.O.D. - depth of discharge  
S.O.C. - state of charge